

# AUTOMIX 30

## Electronic Temperature Control

### MOUNTING AND OPERATION INSTRUCTIONS

Automix 30 is an electronic temperature control for hydronic radiator and radiant floor heating applications. Automix 30 is ready for mounting and can easily be integrated in existing heating systems. The main supply and all sensors have plug-in connections. The quick and easy do-it-yourself installation saves on labor charges.

Automix 30 works continuously and proportionally. Through impulses from the sensors the controller directs the motor to keep the valve plug in the position that corresponds to the present heat requirement of the house.

### THREE MODELS

- **AUTOMIX 30 E** Electronic programmer with 24 h program facility for night setback once in a 24 h period.
- **AUTOMIX 30 Q** Quartz programmer with day- and weekly program facility for night setback 6 times in a 24 h period. The programmer has 150 h spring reserve.
- **AUTOMIX 30 D** Digital programmer with day- and weekly program facility for night setback 8 times in a 24 h period. The programmer has 150 h spring reserve.

### DELIVERY PARTS

1. Electronic controller AM 30 E, AM 30 Q or AM 30 D with four LEDs for indication.
2. AUTOMIX 52B valve motor 24 VAC 50/60 Hz with 1.5 m wire.
3. Supply water sensor T1 with 2 m wire.
4. Outdoor sensor T2 with 15 m wire.
5. Power supply plug-in transformer 230/18 VAC 50/60 Hz 200 mA with 1.7 m wire.
6. Socket.

### OPTIONALS

- **AM 30 RA** room sensor with 15 m wire designed for AUTOMIX 30 E. The room sensor has settings for programming night setback and LEDs for indication.
- **AM 30 RB** room sensor with 15 m wire designed for AUTOMIX 30 Q and AUTOMIX 30 D. The room sensor has LEDs for indication.
- **AM 30 RC** remote control with 15 m wire for parallel displacement of regulating graph. AM 30 RC is used instead of a room sensor. With the remote control the supply water temperature can be lowered by up to 9°C and risen by 6°C.
- **AM 30 PC** pump control with 2 m wire for warm weather shut down. A LED indicates pump off. An interval control starts the circulation pump and the mixing valve for a short time once every 48 h.

### CONTROLLER

- A. Quartz programmer
- B. Pegs
- C. Time marking arrow
- D. Graph setting
- E. Min. supply temperature
- F. Parallel displacement of graph
- G. Max. supply temperature
- H. Temperature setback
- I. Right/left direction of motor
- J. Yellow LED - temperature setback on
- K. Green LED – day temperature on
- L. Program selector
- M. Red LED - mixing valve opens
- N. Red LED – mixing valve closes

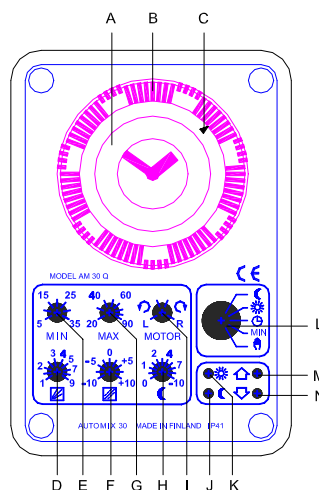

## INSTALLATION

### Controller

The socket is mounted directly on a valve or on a wall. When mounted on the wall the socket is cut out. See **K** below. The controller is placed on the socket.

### Supply water sensor T1

Supply water sensor T1 is fastened on a non-insulated part of the supply pipe 1 m after the mixing valve. For optimum temperature measuring the pipe has to be insulated afterwards.

### Outdoor sensor T2

Outdoor sensor T2 is mounted on the north or north-western outdoor wall at least 3 metres (9 feet) above ground. The outdoor sensor must never be mounted above a window or near an air valve as this would influence the sensor.

### Room sensor AM 30 RA/RB

Room sensor AM 30 RA/RB (optional) is mounted at a place with an average temperature of the house. The room sensor should not be placed where it can be affected by direct sunshine, heat radiation or draught. Radiators with thermostatic valves in the same room as the room sensor must be max. opened to obtain a correct controlling.

## AUTOMIX 52B VALVE MOTOR

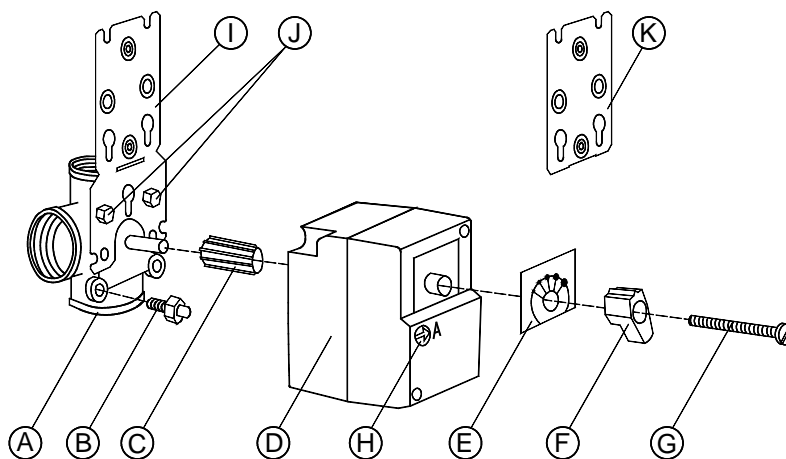

1. Turn the spindle of the valve **A** counter clockwise to the end position (open or closed). Remove the knob/handle without changing the position of the spindle. Fasten the socket **I** with screws **J** or fasten the socket **K** to the wall.
2. Screw the anti-rotation stop **B** in a convenient hole on the valve (if necessary remove an existing screw).
3. Slide the linkage **C** over the valve spindle. Place the motor **D** onto the linkage **C** until the anti-rotation stop **B** engages in the slot of the motor.
4. The motor is supplied in the anti-clockwise position. Turn the scale **E** according to the open/closed direction of the valve.
5. Place the handle **F** onto the motor ensuring that the arrow points to the left end position of the scale. Tighten the hole unit by means of screw **G**.
6. Using a screwdriver (No.3) turn the disengaging button **H** from "A" to "HAND" position and rotate the valve by means of handle **F** from one end position to the other. **It is important that the motor can be moved from one end stop to the other (90°)**
7. Connect the motor wire to the MOTOR-connection on the control unit.
8. Turn the disengaging button **H** back to "A" which is the AUTOMATIC-position.

# WIRING

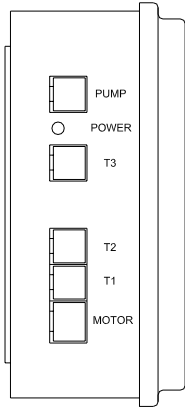

Automix 30 is delivered factory pre-wired. Plug the sensors T1, T2, adapter and the optionals AM 30 RA/RB/RC or PC into the controller.

The factory pre-wired cables can be lengthened. The **two wires in the middle** of the 4-wire cable are to be lengthened.

## MOUNTING OF AUTOMIX 30

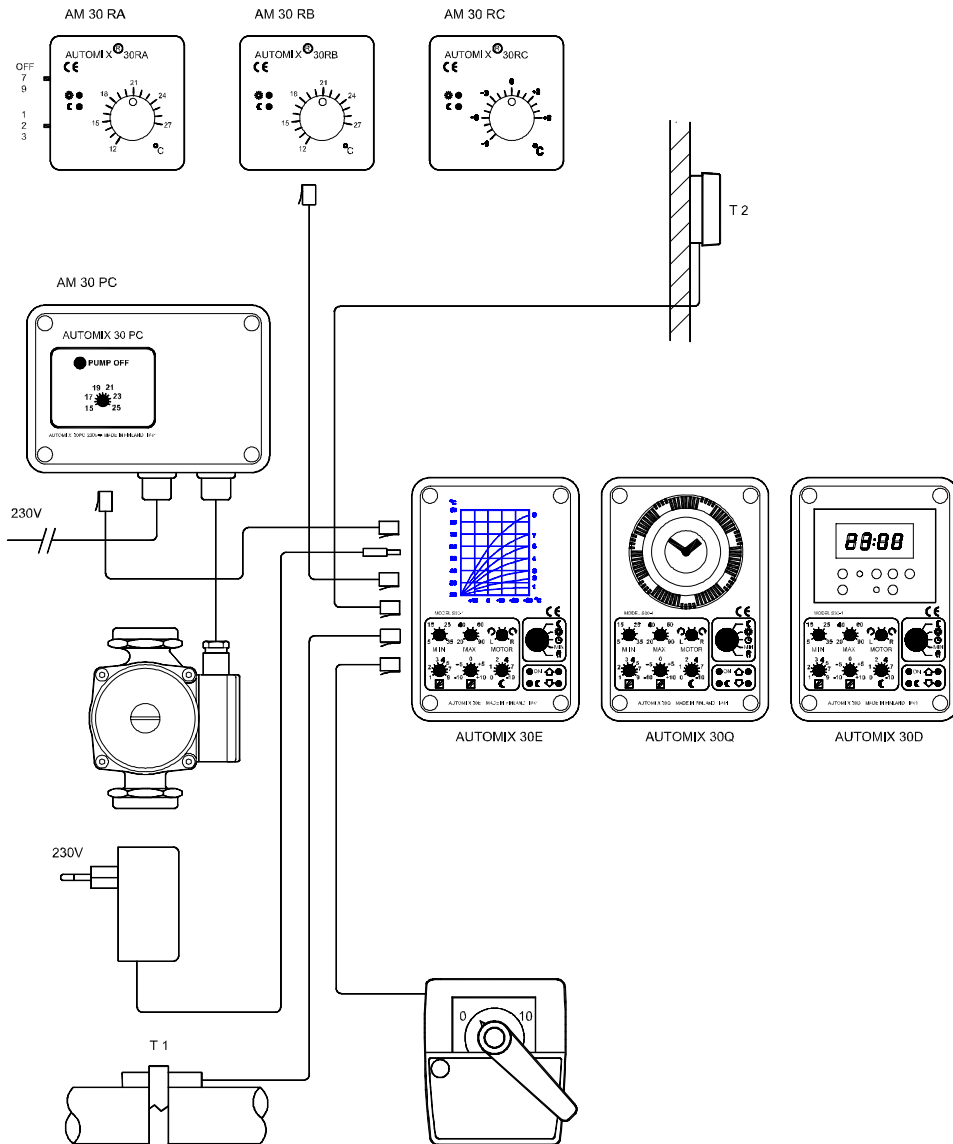

## GRAPH SETTING

The regulating graph for a certain house is dependent on dimensions, location, insulation etc. Therefore it is not possible to decide on a graph in advance. It has to be tried out. The graph is set with knobs **D** and **F**. The knobs work steplessly.

### Starting values

Regulating graph for radiator heating, set knob **D** on **6**.  
Regulating graph for floor heating, set knob **D** on **3**.

### Room temperature setting

Knob **F** grading  $\pm 10^{\circ}\text{C}$  means that the supply water temperature can be raised or lowered by  $10^{\circ}\text{C}$  from setting 0.  $2,5^{\circ}\text{C}$  supply water temperature corresponds to  $1^{\circ}\text{C}$  room temperature. Use knob **F** to find the wanted room temperature.

### Adjustments

If the room temperature rises with falling outdoor temperature:      lower knob **D**  
raise knob **F**

If the room temperature falls with falling outdoor temperature:      raise knob **D**  
lower knob **F**

Make only very small changes with knobs **D** and **F**. When the house has an even temperature despite fluctuating outdoor temperatures, the correct regulating graph has been obtained.

**N.B!** Heat affects slowly. When the temperature setting has been changed it takes several hours before the room temperature corresponds to the new setting due to dimensions of the heating system and the insulation of the house. A floor heating system responds even slower to a new setting than a radiator system.

## REGULATING GRAPH

Supply water temperature  $^{\circ}\text{C}$

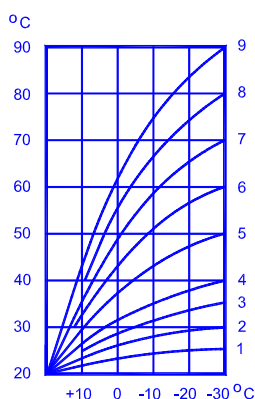

Outdoor temperature

## NIGHT SETBACK PROGRAMMING

**AUTOMIX 30 E** has an electronic programmer with 24 h program facility for night setback once in a 24 h period. The setback period is **7 hours**. To program night setback, the program selector has to be switched from **day temperature** to **setback temperature** at the time the setback is to be initiated. The setback can start anytime. For example, if the setback period is to start at 10.00 PM (22.00) the program selector is switched from **day temperature** to **setback temperature** at 10.00 PM. (22.00) The setback temperature will now last for 7 hours until 5.00 AM (05.00) and then return to normal room temperature. Once set, the setback period will repeat every 24 hours, until another setting is programmed. In case of a power failure during the setback period the yellow and green LEDs start flashing alternately. In this case the night setback has to be re-programmed.

The setback temperature is selected with knob **H**. Knob **H** grading  $0^{\circ}$ - $10^{\circ}\text{C}$  means that the supply water temperature can be lowered by  $10^{\circ}\text{C}$  from setting 0.  $2,5^{\circ}\text{C}$  supply water temperature corresponds to  $1^{\circ}\text{C}$  room temperature.

**N.B!** With a connected room sensor **AM 30 RA/RB** the knob **H** grading means  $0^{\circ}$ - $10^{\circ}\text{C}$  room temperature.

**AUTOMIX 30 Q** has a quartz programmer with day- and weekly program facility for night setback 6 times in a 24 h period. The programmer has 150 h spring reserve.

Coarse adjustment: Turn switching dial in the direction of the arrow until the current day of the week is opposite the marking arrow **C**.

Fine adjustment: Continue turning the minute hand in the direction of the arrow until the current time is opposite the marking arrow **C**.

The control comes with factory pre-set switching times. Night setback starts at 10.00 PM (22.00) and day temperature at 6.00 AM (06.00).

The control is easily re-programmed. The setback period is changed by pressing the desired amount of pegs **B** towards the edge of the programmer. One peg equals 2 hours. Return to day temperature occurs at the next unpressed peg. Shortest make-time is 2 h.

The setback temperature is selected with knob **H**. Knob **H** grading 0°-10°C means that the supply water temperature can be lowered by 10°C from setting 0. 2,5°C supply water temperature corresponds to 1°C room temperature.

**N.B!** With a connected room sensor **AM 30 RA/RB** the knob **H** grading means 0°–10°C room temperature.

**AUTOMIX 30 D** has a digital programmer with day- and weekly program facility for night setback 8 times in a 24 h period. The programmer has 150 h spring reserve. For setting the digital programmer see enclosed instruction.

The setback temperature is selected with knob **H**. Knob **H** grading 0°-10°C means that the supply water temperature can be lowered by 10°C from setting 0. 2,5°C supply water temperature corresponds to 1°C room temperature.

**N.B!** With a connected room sensor **AM 30 RA/RB** the knob **H** grading means 0°–10°C room temperature.





### BOOSTER-FUNCTION

The booster function provides a higher supply water temperature after a temperature set-back period. To reach the normal room temperature more rapidly a higher supply temperature is possible during 45 min. **During the booster period the green and yellow LEDs twinkle in turns.**

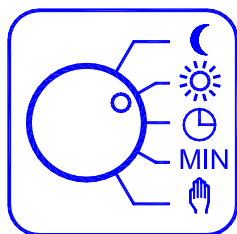
**Hydronic heating systems and especially floor heating systems respond slowly to program changes. After a re-programming it takes one to several hours before the new temperature is actually reached. Consequently, temperature setbacks and setups should be set 1 to 2 hours earlier than the desired time.**

### PROGRAM SELECTOR



-  Night setback temperature
-  Day temperature
-  Automatic day/night setback program
-  Frost protection
-  Manual setting

At frost protection programmer and pump go. The min. supply water temperature is set with knob **E**.

At manual setting the motor does not work. The pump runs. Using a screwdriver turn the disengaging button **H** from “A” to “HAND”. The valve can now be adjusted manually.

### MIN./MAX. SUPPLY WATER TEMPERATURE

Adjustment of min./max. temperature of the supply water temperature is used in floor heating systems. Min. temperature is adjusted with knob **E** and max. temperature with knob **G**.

### RIGHT/LEFT DIRECTION OF MOTOR

Right or left direction of motor is selected with knob **I**. Set the the selector at **L** or **R**. The LEDs **M** and **N** indicate motor opening and closing respectively.

### AM 30 RA/RB ROOM SENSORS

The room sensor (optional) should be mounted at a place that has an average temperature of the house. It must not be placed where it can be affected by direct sunshine, heat radiation or draught. The room sensor is delivered with 15 m wire.

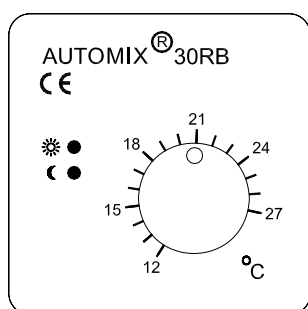
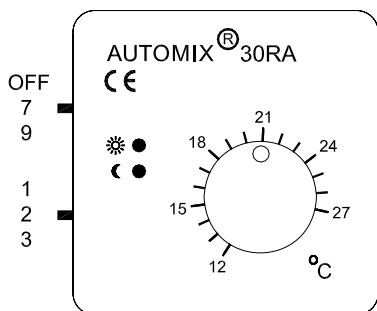

**AM 30 RA** is designed for AUTOMIX 30 E. The night setback is programmed with switch **A** on the room sensor. The yellow and green LEDs indicate night setback and day program respectively. A setback period can start anytime. To program night setback, switch **A** has to be set from **0** to either **7** or **9** at the time the setback is to be initiated. To obtain e.g. a 7 hour setback starting at 10.00 PM (22.00) switch **A** is set from **0** to **7** at 10.00 PM (22.00). The setback temperature will now last for 7 hours until 5.00 AM (05.00) and then return to normal day temperature. Once set, the night setback will repeat every 24 hours, until another setting is programmed. N.B. To change a setback period switch **A** is to be set first on **0** and then on desired setback period.

After a power failure during a setback period the yellow and green LEDs start flashing alternatingly. In this case the night setback has to be re-programmed. The room temperature can be reduced by 1°, 2° or 3°C with switch **B**.

**AM 30 RB** is designed for AUTOMIX 30 Q and D. The green and yellow LEDs indicate day- and night setback program respectively.

### AM 30 RC REMOTE CONTROL

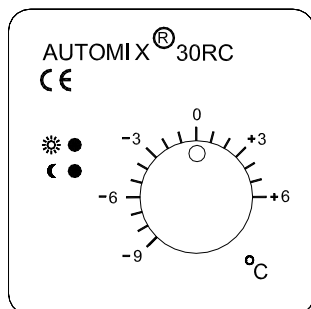

**AM 30 RC** remote control is designed for floor-heating systems. The remote control has the same function as knob **F** on the controller i.e. parallel displacement of the regulating graph. With the remote control the supply water temperature can be lowered by 9°C and risen by 6°C.

### AM 30 PC PUMP CONTROL

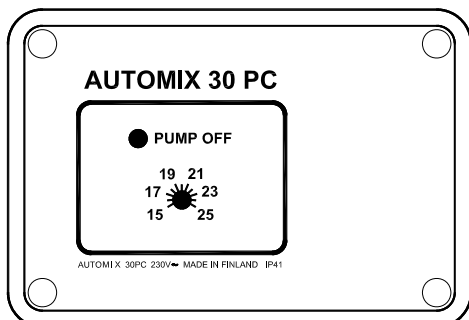

**AM 30 PC** pump control shuts off the pump as soon as the outdoor temperature reaches the selected setting +15°C... +25°C. A green LED indicates pump off. An interval control starts pump and mixing valve for a short period once every 48 h.

## SENSOR RESISTANCE

To check the sensors, the resistance is measured at the two wires in the middle of the 4-wire cable contact.

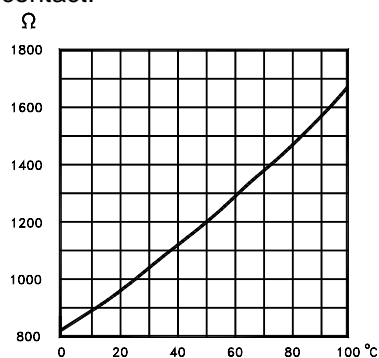

Supply water sensor T1

°C	Ω
0	820
10	889
20	962
30	1039
40	1118
50	1202
60	1288
70	1379
80	1472
90	1569
100	1670

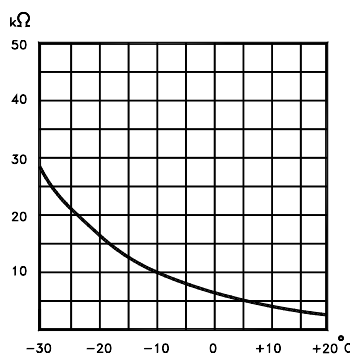

Outdoor sensor T2

°C	kΩ
20	2,67
15	3,28
10	4,06
5	5,04
0	6,31
-5	7,93
-10	10,05
-15	12,84
-20	16,54
-25	21,40
-30	27,93

## TROUBLE SHOOTING

**N.B!** Heat affects slowly. When the temperature setting has been changed it takes some hours before the room temperature corresponds to the new setting due to dimensions of the heating system and the insulation of the house. A floor heating system responds slower to a new setting than does a radiator system.

Should the heating system not work satisfactorily - check that

1. the boiler or storage tank temperature is correct ( 50°C - 90°C).
2. the power is on.
3. the circulating pump runs.
4. no fuses are broken.
5. the radiator and the valves are open.
6. the wiring is correct.
7. the program selector is in a correct position.
8. the programmer is going and the pegs are correctly placed.
9. there is no air in the heating system.
10. the mixing valve turns easily.
11. all knobs are in the correct position.
12. at least one radiator is without a thermostatic radiator valve to guarantee circulation.
13. the resistance/temperature relations are correct according to the curves.

## TECHNICAL DATA

Type of control	PI-control with microprocessor
Voltage	18 VAC 50/60 Hz
Power supply transformer	230/18 VAC 200 mA with 1.7 meter wire
Power consumption	3 VA
Torque, motor	5 Nm
Angle of rotation, motor	electrically limited to 90°
Min. supply water limiter	+5°C... +35°C, supply water temperature
Max. supply water limiter	+20°C... +90°C, supply water temperature
Freeze protection	+5°C... +35°C, supply water temperature
Pump control AM 30 PC	+15°C... +25°C, outdoor temperature
Heating curve	1 ... 9, stepless
Parallel displacement	+/- 10°C supply water temperature, stepless
Remote control AM 30 RC	+/- 15°C supply water temperature, stepless
Night setback	0 ... 10°C, supply water temperature, stepless
Room temperature setting	+12°C ... +27°C, stepless
Protection class, controller	IP 41
Protection class, motor	IP 41
Manual operation	Yes, in case of power failure
Dimensions, controller	125 x 85 x 55 mm
Weight	1,3 kg